

USER MANUAL

MERSEYSIDE ELECTRIC FIREPLACE

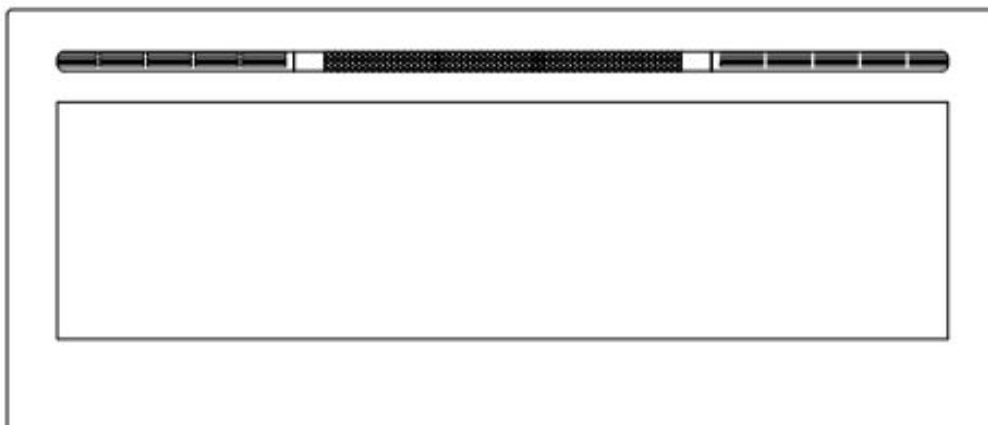

AC 220V-240V 50Hz 1400-1600 W

⚠ WARNING

Read and understand this entire owner's manual, including **all safety information**, before plugging in or **using** this product. Failure to do so could result in **fire, electric shock, or serious personal injury**.

⚠ CAUTION

Keep this owner's manual for future reference. If you sell or give this product away, **make sure this manual accompanies this product**.



IMPORTANT SAFETY INFORMATION!

WARNING

When using electrical appliances basic precautions should always be followed to reduce the risk of fire, electric shock and injury to persons, including the following:

- Read all instructions before using this heater.
- This heater is hot when in use. To avoid burning, do not touch hot surface. If provided, use handles when moving this heater. Keep combustible materials, such as furniture, pillows, bedding, papers, clothes, and curtains at least 1 m from the front of the heater and keep them away from the sides and rear. In order to avoid overheating, do not cover the heater.
- Extreme caution is necessary when any heater is used near children or the infirm and whenever the heater is left operating and unattended.
- Always unplug heater when not in use.
- Do not operate any heater with a damaged cord or plug or after the heater malfunctions, has been dropped damaged in any manner, return heater to authorized service facility for examination, electrical or mechanical adjustment, or repair.
- Indoor use only, do not use outdoors.
- This heater is not intended for use in bathrooms, laundry areas and similar indoor locations. Never locate heater where it may fall into a bathtub or other water container.
- Do not run cord under carpeting. Do not cover cord with throw rugs, runners, or similar coverings. Arrange cord away from traffic area and where it will not be tipped over.
- To disconnect heater, turn controls to off, then remove plug from outlet.
- Do not inset or allow foreign objects to enter any ventilation or exhaust opening as this may cause an electric shock or fire, or damage the heater.
- To prevent a possible fire, do not block air intakes or exhaust in any manner. Do not use on soft surfaces, like a bed, where openings may become blocked.
- A heater has hot and arcing or sparking parts inside. Do not use it in areas where gasoline, or flammable liquids are used or stored.
- Use this heater only as describes in this manual. Any other use not recommended by the manufacturer may cause fire, electric shock, or injury to persons.
- DANGER-HIGH Temperatures may be generated under certain abnormal conditions. Do not partially or fully cover or obstruct the front of this heater.
- Replacement of the lamps should be done only while the heater is disconnected from the supply circuit.
- This appliance is not intended for use by persons (including children) with reduced physical, sensory or capabilities, or lack of experience and knowledge, unless they have been given supervision or instruction concerning use of the appliance by a person responsible for their safety. Children should be supervised to ensure that they do not play with the appliance.
- CAUTION: In order to avoid a hazard due to inadvertent resetting of the thermal cut-out, this appliance must not be supplied through an external switching device, such as a timer, or connected to a circuit that is regularly switched on and off by the utility.

Preparation









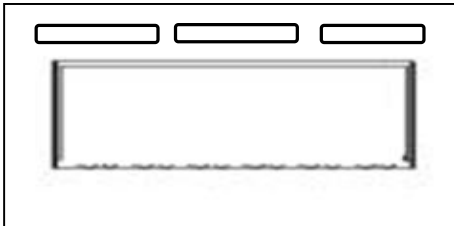

This product includes a **GLASS panel!** Always use **extreme caution** when handling **glass**. Failure to do so could result in **personal injury** or **property damage**.

Remove all parts and hardware from the carton and place them on a clean, soft, dry surface. Parts and assembly steps are grouped for wall-hanging or recessing use. Check the parts list to make sure nothing is missing. Dispose of packaging materials properly. Please recycle whenever possible.

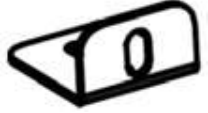
You will need the following tools (not included): Phillips screwdriver; stud finder; level; tape measure; electric drill; 1/4" wood drill bit, hammer.

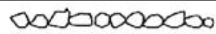
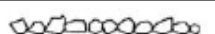
Parts and Hardware

 <p>A – Fireplace</p>	 <p>B – Wood Screws</p>		 <p>C – Drywall anchors</p>	
	 <p>Remote Control</p>		 <p>D - Metal Bracket</p>	
	 <p>E-Wall Bracket Fixed on back of firebox</p>	 <p>F-Decorative Pebbles <input type="checkbox"/></p>	 <p>G-Decorative Crystals <input type="checkbox"/></p>	 <p>H - Log set <input type="checkbox"/></p>

Specification and Dimension

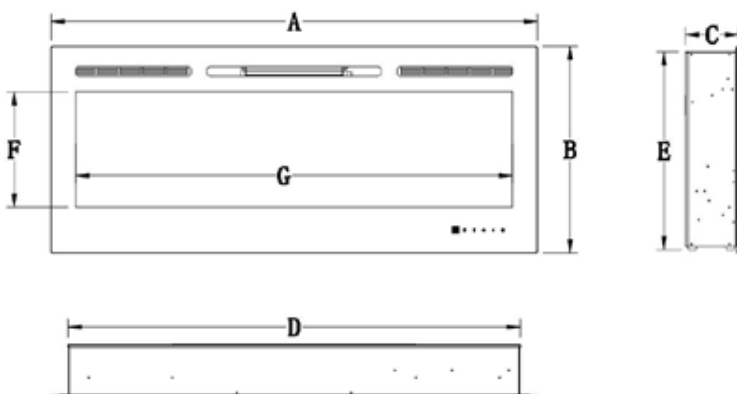

Description	Electric Fireplace
Type	3 Way Mounting Unit Wall-Mount, Recess into Wall and Assemble with mantel
Voltage	220 - 240 V AC
Watts	1400 - 1600 W
Amps	7 AMP Grounded Circuit

PRODUCT DIMENSIONS

Model Number	A	B	C	D	E	F	G
36"	36" 91.5cm	21.46" 54.4cm	5.51" 14cm	32.48" 82.5cm	20.51" 52.1cm	12" 30.5cm	30.91" 78.5cm
45"	45" 114.3cm	21.46" 54.4cm	5.51" 14cm	39.88" 101.3cm	20.51" 52.1cm	12" 30.5cm	38.31" 97.3cm
50"	50" 128cm	21.46" 54.4cm	5.51" 14cm	46.85" 119cm	20.51" 52.1cm	12" 30.5cm	45.28" 115cm
55"	55" 139.7cm	21.46" 54.4cm	5.51" 14cm	46.85" 119cm	20.51" 52.1cm	12" 30.5cm	45.28" 115cm
60"	60" 152.4cm	21.46" 54.4cm	5.51" 14cm	46.85" 119cm	20.51" 52.1cm	12" 30.5cm	45.28" 115cm
65"	65" 165.1cm	21.46" 54.4cm	5.51" 14cm	61.5" 156.1cm	20.51" 52.1cm	12" 30.5cm	59.8" 152.1cm
72"	72" 182.8cm	21.46" 54.4cm	5.51" 14cm	68.39" 173.72m	20.51" 52.1cm	12" 30.5cm	66.82" 169.72cm
100"	100" 254cm	21.46" 54.4cm	5.51" 14cm	96.39" 244.83cm	20.51" 52.1cm	12" 30.5cm	94.8" 240.84cm

Installation and Assembly

Your appliance is a wall-mounted, recessed and/or mantel installed appliance. Select a suitable location that is not susceptible to moisture and is away from drapes, furniture and high traffic areas.

NOTE: Follow all National and local electrical codes.

MINIMUM CLEARANCE TO COMBUSTIBLES

Measurements are taken from the glass front.			
Bottom	0"	Top	8" (300mm) to mantel
Sides	0"	Top	8" (300mm) to ceiling
Back	0"		

MINIMUM MANTEL CLEARANCES

WARNING

WHEN USING PAINT OR LACQUER TO FINISH THE MANTEL, THE PAINT OR LACQUER MUST BE HEAT RESISTANT TO PREVENT DISCOLOURATION.

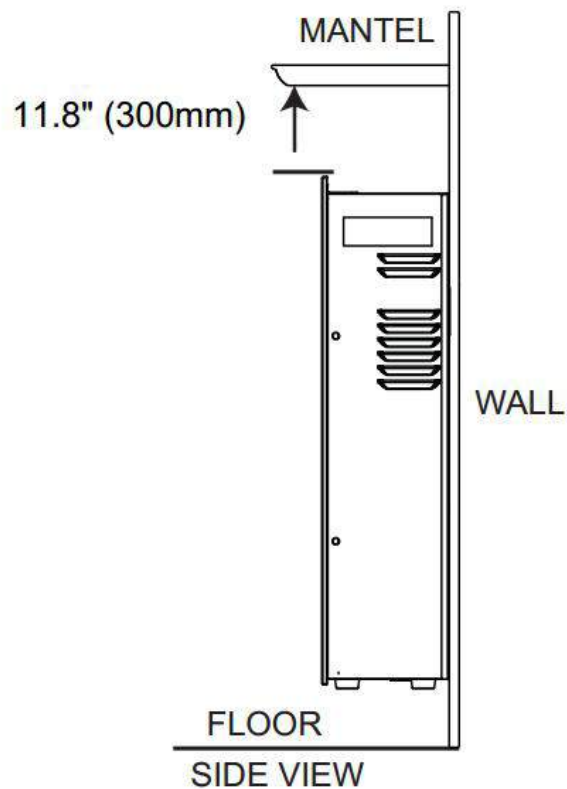

RECESSED TO WALL INSTALLATION

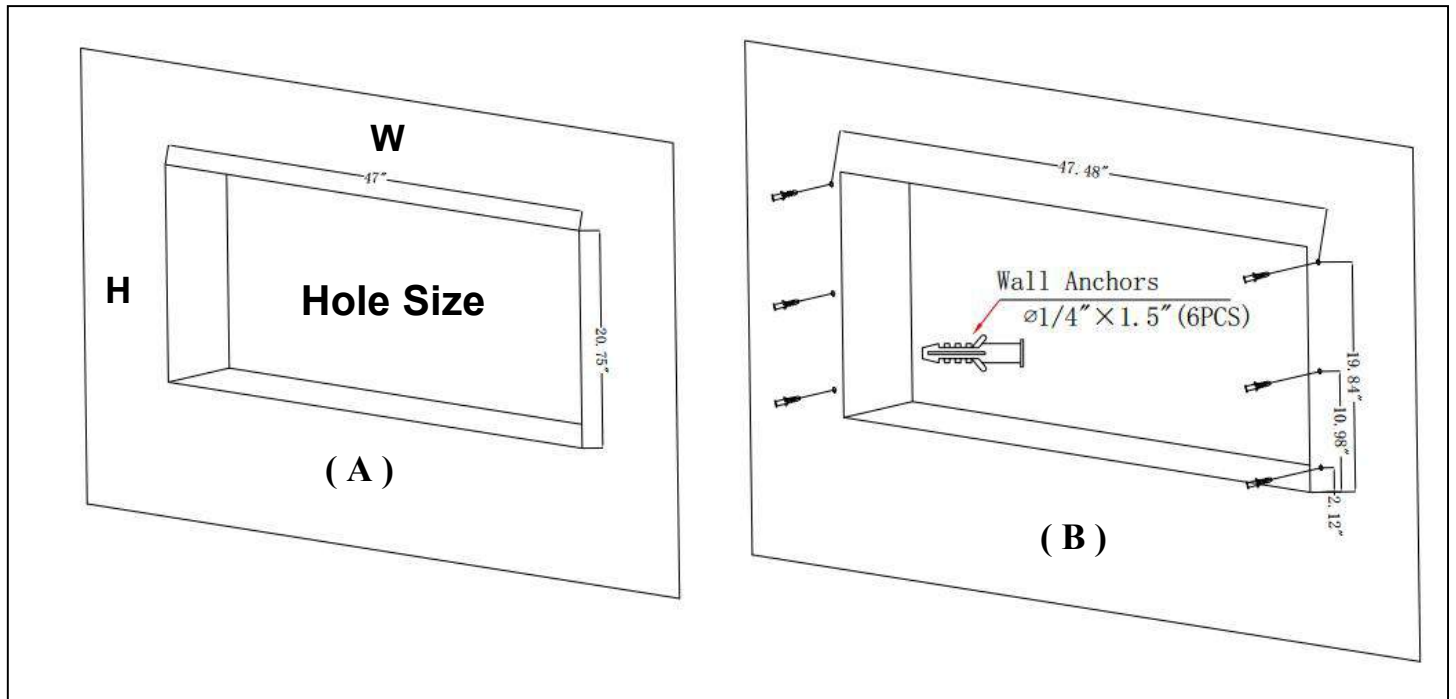

STEP A. Selection a dry wall to open a hole for fireplace box. Size of hole as below chart **Figure (A)**

Framing Hole Size		
Model Number	W	H
36"	33" (83.82CM)	20.75" (52.71CM)
45"	40" (101.6CM)	20.75" (52.71CM)
50"	47" (119.38CM)	20.75" (52.71CM)
55"	47" (119.38CM)	20.75" (52.71CM)
60"	47" (119.38CM)	20.75" (52.71CM)
65"	62" (157.48CM)	20.75" (52.71CM)
72"	69" (175.26CM)	20.75" (52.71CM)
100"	97" (246.38CM)	20.75" (52.71CM)

STEP B. Fix the three wall anchors in each side of the fireplace box according to the dimensions showed on the drawing. **Figure (B)**

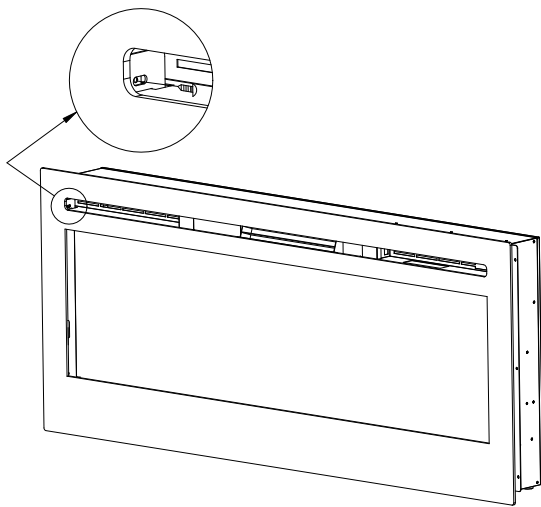

(C)

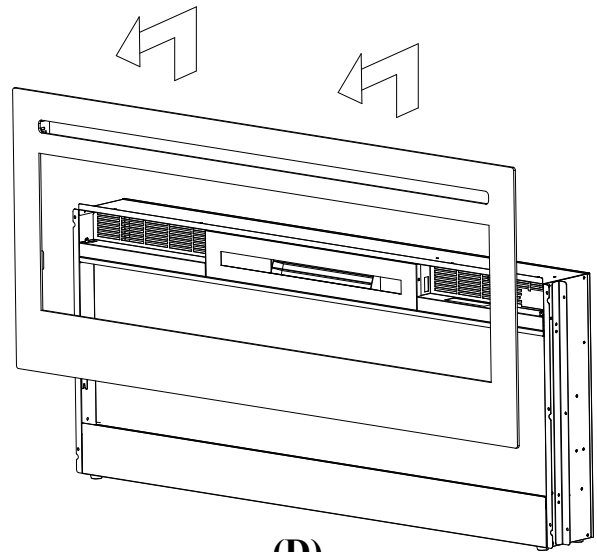

(D)

STEP C. Take off the two screws in both sides of the glass panel. **Figure (C)**

STEP D. Have two person to take the glass panel out of the fireplace box. Place it to a soft and clean place. **Figure (D)**

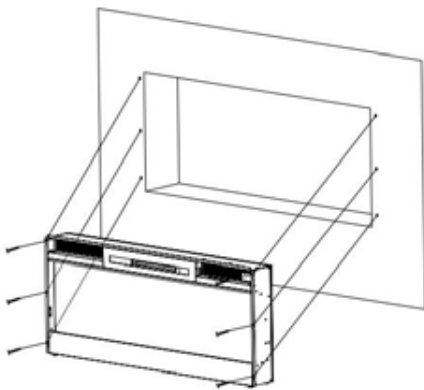

(E)

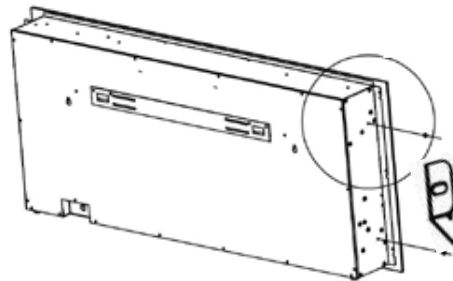

(F)

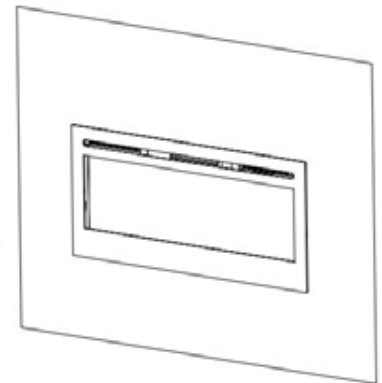

(G)

STEP E. Have two person to move the fireplace box to the wall hole.

If the appliance is fully recessed into the wall:

- Use the 6 screws (provided) to lock the appliance into the wall with the existing two side flanges, see **Figure (E)**
- Install the media and re-install the glass front.

If partial recess into the wall:

- Use the four mounting metal brackets (supplied) to lock the appliance to the wall, see **Figure (F)**

NOTE: Using the existing holes on sides of the appliance for recessing into wall.

STEP F.Fireplace will be like this after installation **Figure (G)**

Wall Mounted Installation

Due to the many different materials used on different walls, it is highly recommended that you consult your local builder before you install this appliance on the wall.

A. Select a location that is not prone to moisture and is located at least 36" (914mm) away from combustible materials such as curtain drapes, furniture, bedding, paper, etc.

B. Have two people hold the appliance against the wall to determine the final location.

C. Place unit face down on a soft, non abrasive surface. Remove the bracket from the back of the unit by removing the screws, refer to Figure 1.

D. Mark out location, then mount the bracket(s) onto the wall using the supplied screws. This bracket

MUST have the hooks facing upward and be level. **NOTE: It is strongly**

recommended that the mounting bracket (E) be Screwed into the wall studs Where possible. If the wall Studs cannot be used, ensure

That the supplied plastic anchors are used to affix the bracket to the wall and the bracket is adequately secured.

E. With the wall mounting bracket installed have two people lift the appliance up and insert the two hooks

on the bracket into the two slots on the back of the appliance.

F. Check the appliance for stability ensuring that the bracket will not pull free from the wall.

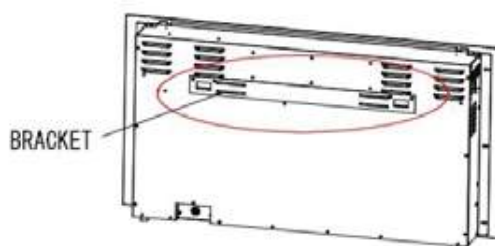
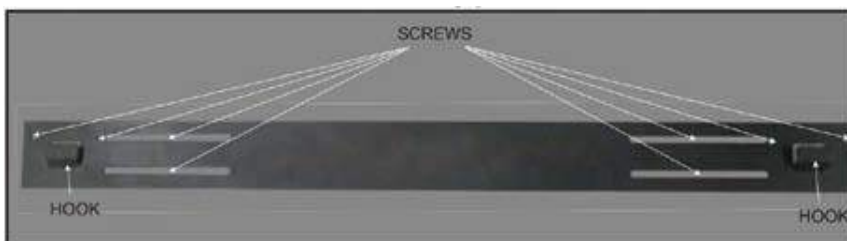
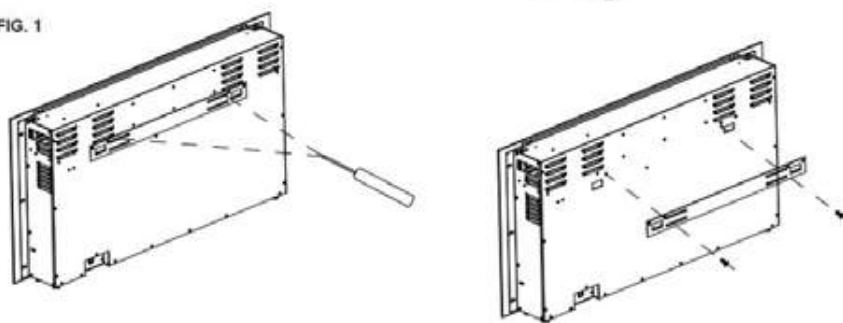
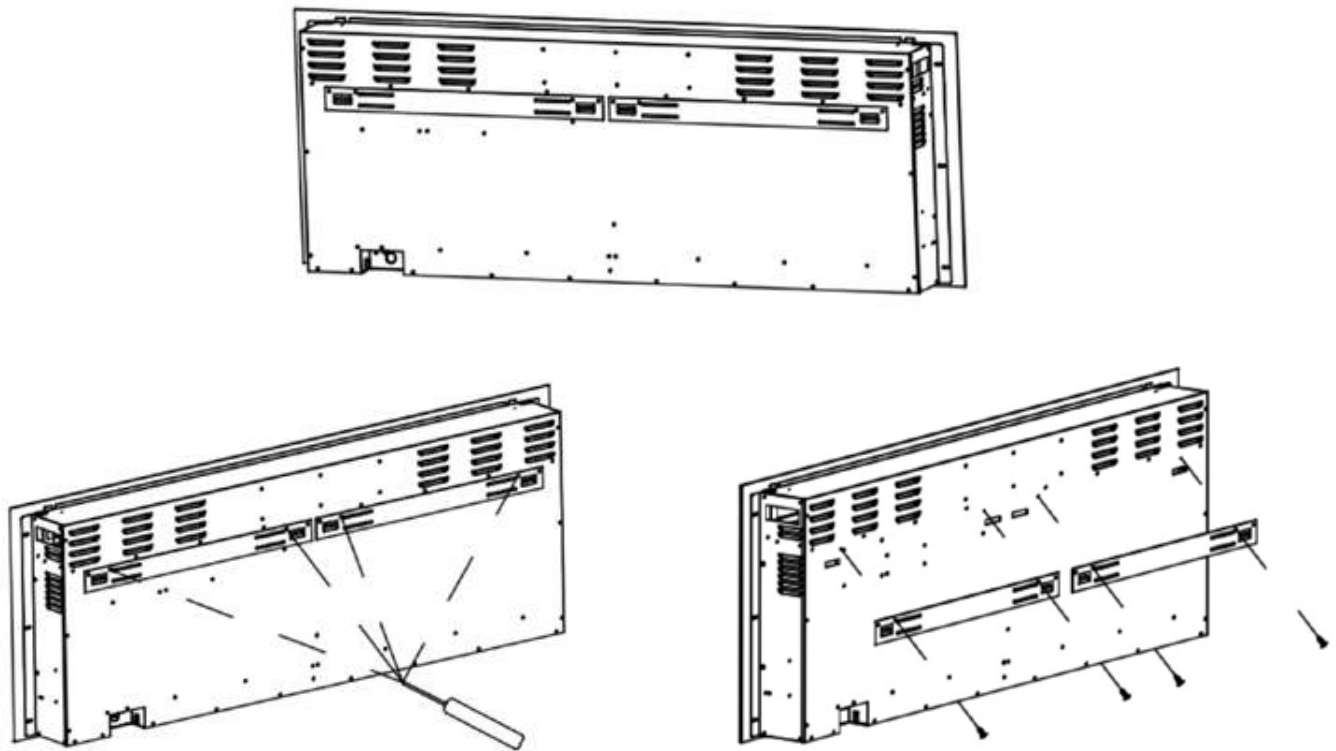

FIG. 1



36/45/50/60 Wall Bracket Illustrated



65/72/100 Wall Bracket Illustrated

Logset / Crystal / Pebble Ember Installation

(NOTE: Please make the installation according to the embers which you bought or selected.)

- A. Glass front must be removed and the appliance must be mounted in its final location before the logset / crystal / pebble embers are installed.
- B. If your fireplace come with logset, You do not need to do anything just use as it is . **Figure 1.**
- C. If your fireplace come with CLEAN CRYSTAL or PEBBLE MEDIA: Crystal or pebbles media may have a fine oil residue that needs to be cleaned prior to installation. Clean the them with mild dish soap, drain, rinse thoroughly and dry before placing into the tray.
- D. Place the plastic tray (I) to the fireplace designed place. Then carefully place crystal or pebbles embers into the bottom tray on the front of the appliance as illustrated. Apply an even layer from side to side. **Figure 2, Figure 3.**

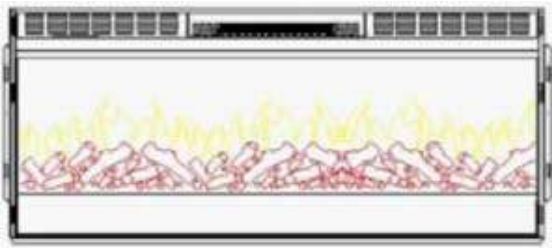

Figure 1.

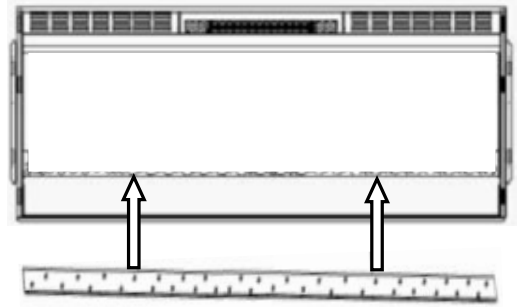

Figure 2.



Figure 3. (Crystal medias)



Figure 3. (Pebbles medias)

Operation



Read and understand this entire owner's manual, including **all safety information**, **before plugging in** or **using** this product. Failure to do so could result in **electric shock**, **fire**, **serious injury**, or **death**.

Power

Plug the power cord into a AC 220-240 Volt outlet (see **IMPORTANT SAFETY INFORMATION** on **Pages 2 and 3**). Make sure the outlet is in good condition and that the plug is not loose. **NEVER** exceed the maximum amperage for the circuit. **DO NOT** plug other appliances into the same circuit.







Methods of Operation

This electric fireplace can be operated by the CONTROL PANEL/TOUCH PANEL, or by the battery-powered REMOTE CONTROL.

The operation and functions of the two methods are the same.





Before operating, please review the **IMPORTANT SAFETY INFORMATION** on **Pages 2 and 3**, and heed all warnings.

Control Panel / Remote Control Operation

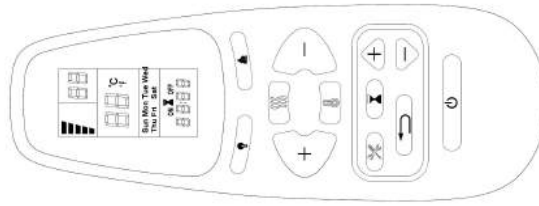



BUTTON	FUNCTION	ACTION & INDICATION																																																								
 POWER	<p>ON: Enables control panel functions and remote control. Turns on flame effect.</p> <p>OFF: Disables control panel functions and remote control. Turns off flame effect.</p>	<ol style="list-style-type: none"> Press once. Indicator light turns on. Power turns on. All functions enabled. Press again. Flame effect turns off. Power and all functions turn off. 																																																								
 TIMER	<p>TIMER button: Controls timer settings to turn off fireplace at selected time. Settings range from 0.5 hours to 8 hours.</p>	<ol style="list-style-type: none"> Press once. Indicator light turns on. Timer is set to 0.5 hours. Press again until desired setting is reached. Display window shows setting. 																																																								
 FLAME	<p>FLAME button: Makes flame effect dimmer and brighter.</p> <p>NOTE: Flame effect stays on until power button is turned off. Flame effect must be on for heater to turn on.</p>	<ol style="list-style-type: none"> Press once. Indicator light turns on. Flame brightness effect gets changing. Press again. until desired setting is reached. 																																																								
 COLOR	<p>COLOR button: Makes the color flame effect changing.</p> <p>NOTE: color effect stays on until power button is turned off. Color flame effect must be on for heater to turn on.</p>	<ol style="list-style-type: none"> Press once. Indicator light turns on. Flame color effect gets changing. Press again until desired setting is reached. Display window shows setting. 																																																								
 HEATER	<p>HEATER button: Turns heater on and off.</p> <p>NOTE: The heater only works when the flame effect is on. If the flame effect is off, the heater will not turn on.</p> <p>NOTE: To prevent overheating, the heater blows cool air for 10 seconds before the heater turns on, and after it turns off.</p>	<ol style="list-style-type: none"> Press once. Indicator lights up. Fan blows cool air for 10 seconds. Low heater turns on and blows warm air. Press again. Indicator lights up. High heater turns on and blows hot air. Press again. Heaters turn off. The fan blows cool air, then turns off. 																																																								
 TEMP	<p>TEMPERATURE button: Turns heater on and off.</p> <p>NOTE: Press & Hold the button for 5 seconds, the temperature setting will switch from °C to °F. Same way from °F to °C.</p>	<ol style="list-style-type: none"> Press once: Indicator lights up. Temperature goes to 18 °C Press again: until desired setting is Reached. Digital display shows setting circles as below: 																																																								
	<table border="1"> <thead> <tr> <th>NO</th> <th>0</th> <th>1</th> <th>2</th> <th>3</th> <th>4</th> <th>5</th> <th>6</th> <th>7</th> <th>8</th> <th>9</th> <th>10</th> <th>11</th> <th>12</th> </tr> </thead> <tbody> <tr> <td>°C</td> <td>18</td> <td>19</td> <td>20</td> <td>21</td> <td>22</td> <td>23</td> <td>24</td> <td>25</td> <td>26</td> <td>27</td> <td>28</td> <td>29</td> <td>30</td> </tr> <tr> <td>°F</td> <td>64</td> <td>66</td> <td>68</td> <td>70</td> <td>72</td> <td>74</td> <td>76</td> <td>78</td> <td>80</td> <td>82</td> <td>84</td> <td>86</td> <td>88</td> </tr> <tr> <td></td> <td>65</td> <td>67</td> <td>69</td> <td>71</td> <td>73</td> <td>75</td> <td>77</td> <td>79</td> <td>81</td> <td>83</td> <td>85</td> <td>87</td> <td></td> </tr> </tbody> </table>	NO	0	1	2	3	4	5	6	7	8	9	10	11	12	°C	18	19	20	21	22	23	24	25	26	27	28	29	30	°F	64	66	68	70	72	74	76	78	80	82	84	86	88		65	67	69	71	73	75	77	79	81	83	85	87		
NO	0	1	2	3	4	5	6	7	8	9	10	11	12																																													
°C	18	19	20	21	22	23	24	25	26	27	28	29	30																																													
°F	64	66	68	70	72	74	76	78	80	82	84	86	88																																													
	65	67	69	71	73	75	77	79	81	83	85	87																																														

Remote Control Operation

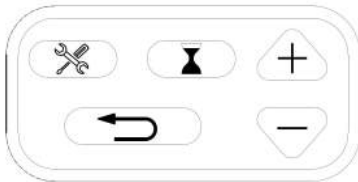

BUTTON	FUNCTION	ACTION & INDICATION
 POWER	<p>ON: Enables control panel functions and remote control. Turns on flame effect.</p> <p>OFF: Disables control panel functions and remote control. Turns off flame effect.</p>	<ol style="list-style-type: none"> Press once. Indicator light turns on. Power turns on. All functions enabled. Press again. Flame effect turns off. Power and all functions turn off.
	<p>COLOR button: Makes the color flame effect changing.</p> <p>NOTE: color effect stays on until power button is turned off. Color flame effect must be on for heater to turn on.</p>	<ol style="list-style-type: none"> Press once. Indicator light turns on. Flame color effect gets changing. Press again until desired setting is reached. Display window shows setting.
	<p>FLAME button: Makes flame effect dimmer and brighter.</p> <p>NOTE: Flame effect stays on until power button is turned off. Flame effect must be on for heater to turn on.</p>	<ol style="list-style-type: none"> Press once. Indicator light turns on. Flame brightness effect gets changing. Press again. until desired setting is reached.
 HEATER	<p>HEATER button: Turns heater on and off.</p> <p>NOTE: The heater only works when the flame effect is on. If the flame effect is off, the heater will not turn on.</p> <p>NOTE: To prevent overheating, the heater blows cool air for 10 seconds before the heater turns on, and after it turns off.</p>	<ol style="list-style-type: none"> Press once. Indicator lights up. Fan blows cool air for 10 seconds. Low heater turns on and blows warm air. Press again. Indicator lights up. High heater turns on and blows hot air. Press again. Heaters turn off. The fan blows cool air, then turns off.

TIMER SETTINGS ON REMOTE CONTROL

 : Timer: Displays current day, time, and week. Press to enter or confirm timer settings.	
 : Settings: Press to move to next step (use with Timer button). Press to confirm week timer.	
 : Back: Press to clear timer settings. Press to return to the previous step (use with Settings button).	
 : Up and Down (use with Settings button).	

LCD Screen

Weekday

Mon, Tues, Wed, Thurs, Fri, Sat, Sun

Time Display

Current Time / Timer From 00: 00 to 24
NOTE: 00-12:00 is AM / 13:00-24:00 is PM

Sun Mon Tue Wed
Thu Fri Sat

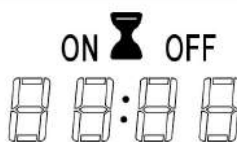

Note: The functions can only be adjusted when the related letters or digits are flashing.

Note: Calibrate the timer to current time before the weekly settings.



TEMP

TEMPERATURE button: Turns heater on and off.







NOTE: Press & Hold the button for 5 seconds, the temperature setting will switch from °C to °F. Same way from °F to °C.

1. **Press once:** Indicator lights up. Temperature goes to 18 °C

2. **Press again:** until desired setting is Reached. Digital display shows setting circles as below:

NO	0	1	2	3	4	5	6	7	8	9	10	11	12
°C	18	19	20	21	22	23	24	25	26	27	28	29	30
°F	64	66	68	70	72	74	76	78	80	82	84	86	88
	65	67	69	71	73	75	77	79	81	83	85	87	

1 Set current day and time

1. Press  once. When "MON" (Monday) begins flashing, use  to select the current day.
2. Press . When the hour digits begin flashing, use  to select the current hour.
3. Press  again. When the minute digits begin flashing, use  to select the current minute.
4. Press  again. The current time is now set.

2 Set ON/OFF time and temperature on a weekly cycle

1. Press . When "MON" begins flashing, press 3 times. When "ON" begins flashing, use to select the desired hour and minute to turn on the heater. at any time to clear the digits and shut down "ON" timer.

note:

The timer can only be adjusted in 30-minute increments (i.e. 00:00 - 00:30; 00:30 - 01:00, etc.)

2. Press . When "OFF" begins flashing, use to select the desired hour and minute to turn off the heater. Press at any time to clear the digits and shut down "OFF" timer.
3. Press again. When "18" begins flashing, use to select the desired temperature for Monday.

note:

If the temperature was previously set, those digits will be shown instead of "18".

4. Press again. When "TUES" appears on the screen and "ON" begins flashing, use to select the desired hour and minute to turn on the heater for Tuesday.
5. Press again. When "OFF" begins flashing, use to select the desired hour and minute to turn off the heater for Tuesday.
6. Press again. When "18" begins flashing, use to select the desired temperature for Tuesday.
7. Repeat steps 1 to 6 to set the "ON/OFF" time and temperature for Wednesday, Thursday, Friday, Saturday, and Sunday.
8. Press or to complete programming, ensuring to aim the remote control at the receiver, located in the middle of the appliance. The appliance will "beep" once to confirm that programming has been successful.

Open window warning

If the room temperature decreases by 10 degrees within 3 minutes, the appliance will assume there is an open window nearby. In order to conserve energy, the heater will automatically switch from High Heat to Low Heat, or if the heater is already at Low Heat, it will turn off completely.

When switching from High Heat to Low Heat, the appliance will beep 3 times and the digital display will flash "88" 3 times before displaying the existing heating status.

When switching from Low Heat to Off, the appliance will beep 3 times and the digital display will flash "88" continuously.

To reset the heating function, see "operating remote control" section.

NOTICE

When the heater is first turned on, a slight odor may be present. This is normal and should not occur again unless the heater is not used for a long period of time.

NOTICE

To improve operation, **aim** the remote control at the front of the fireplace. **DO NOT press the buttons too quickly**. Give the unit time to respond to each command.

Temperature Limiting Control

This heater is equipped with a Temperature Limiting Control. Should the heater reach an unsafe temperature, the heater will automatically turn OFF. To reset:

1. Unplug the power cord from the outlet.
2. Turn the ON/OFF switch on the CONTROL PANEL to OFF. **Wait 5 minutes.**
3. Inspect the fireplace to make sure no vents are blocked, or clogged with dust or lint. If they are, use a vacuum to clean the vent areas.
4. With the POWER switch in the OFF position, plug the power cord back into the outlet.
5. If the problem continues, have your outlet and wiring inspected by a professional.

Remote Control Battery Information

This remote control uses two **AAA** batteries (**Not Included**)



NEVER dispose of batteries in **fire**. Failure to observe this precaution **may result in an explosion**. Dispose of batteries at your local hazardous material processing center.

Care and Maintenance

Cleaning



ALWAYS turn the heater **OFF** and **unplug the power cord from the outlet** before cleaning, performing maintenance, or moving this fireplace. Failure to do so could result in **electric shock, fire, or personal injury**.



NEVER immerse in water or **spray with water**. Doing so could result in **electric shock, fire, or personal injury**.

Metal:

- Buff using a soft cloth, slightly dampened with a citrus oil-based product.
- DO NOT** use brass polish or household cleaners as these products will damage the metal trim.

Glass:

- Use a good quality glass cleaner sprayed onto the cloth or towel. Dry thoroughly with a paper towel or lint-free cloth.
- NEVER** use abrasive cleansers, liquid sprays, or any cleaner that could scratch the surface.

Vents:

- Use a vacuum or duster to remove dust and dirt from the heater and vent areas.

Plastic:

- Wipe gently with a slightly damp cloth and a mild solution of dish soap and warm water.
- NEVER** use abrasive cleansers, liquid sprays, or any cleaner that could scratch the surface.

Maintenance



Risk of electric shock! DO NOT OPEN any panels ! No user-serviceable parts inside!



ALWAYS turn the heater **OFF** and **unplug the power cord from the outlet** before cleaning, performing maintenance, or moving this fireplace. Failure to do so could result in **electric shock, fire, or personal injury**.

Electrical and Moving Parts:

- The fan motors are lubricated at the factory and will not require lubrication.
- Electrical components are integrated in the fireplace and are not serviceable by the consumer.

Storage:

- Store heater in a clean dry place when not in use.



WARNING! NO SERVICING of the internal or electrical parts should be performed by the consumer. Do not service the unit yourself.

Troubleshooting

WARNING

**DISCONNECTED THE APPLIANCE COMPLETELY AND LET COOL PRIOR TO ANY SERVICE.
ONLY A QUALIFIED SERVICE PERSON SHOULD SERVICE AND REPAIR THIS ELECTRIC APPLIANCE.**

Problem	Possible Cause	Solution
1. Fireplace turns off and will not turn on.	1. Fireplace has overheated and safety device has caused thermal switch to disconnect or home circuit breaker has opened.	1. Reset switch by turning main power switch off and waiting 10 minutes then turning it back on or reset circuit breaker.
2. Flame is not moving.	1. Loose wiring. 2. Flame motor defective. 3. Flame rod out of place	1. Inspect wiring for loose connections. 2. Call a qualified service technician to replace flame motor. 3. "Flame Rod" out of place due to rough transit/handling of the product. This issue can be corrected as simple as removing the glass, flipping the fireplace upside down, removing a set of screws that are holding the bottom frame plate and placing the flame rod back into place.
3. Flame is not visible.	1. Wiring is loose.	1. Disconnect from power source and inspect wiring for loose connections and repair or replace if necessary. 2. Push the flame button to high
4. Log set and/or is not glowing.	1. Wiring is loose. 2. Ember is in off mode	1. Disconnect from power source and inspect wiring for loose connections and repair or replace if necessary. 2. Push the ember button is high
5. Remote control does not work.	1. Low batteries. 2. Not aiming control correctly. 3. Defective remote control and /or sensor.	1. Replace batteries in remote control. 2. Aim control at sensor located directly behind glass screen in center of unit just above logs. 3. Replace remote control and/or sensor.
6. Fireplace will not come on when switch is flipped to ON.	1. Fireplace is not plugged in to an electrical outlet. 2. Control failure. 3. Breaker tripped.	1. Check plug. 2. Call a qualified service technician. 3. Reset breaker.

7. Heater does not provide heat when turned on.	1. Thermal switch has been tripped. 2. Wiring is loose. 3. Heater is defective.	1. Turn unit off and unplug unit for 10 minutes. Plug back in and turn unit on. If plug cannot be reached, follow directions for tripped circuit breaker. 2. Disconnect from power source and inspect wiring for loose connections and repair or replace if necessary. 3. Replace heater.
---	---	---

CAUTION: To remove the glass, you will notice two screws on front both sides (right and left) of the fireplace. Once the screws are removed, slide the glass up and away from the fireplace. Once the bottom frame plate is removed, you will notice one flame motor on right side where the rod should be in place with the rubber plugs.

Please remember to always have the unit disconnected prior to any work, always lay glass as well as the unit on a towel or other material not to damage parts/frame.

This entire process should not take longer than 20-30 minutes.
